

Description and application

Ventilation grille for intake and exhaust to spiro ducts. The front frame is shaped according to the channel diameter. Application in low- and medium pressure installations. Recommended is installation in ducts and ventilation openings holes using visible bolts in holes the front frame. The front frame is made of steel profiles. Blades are mounted vertically (STS-S). Adjusting the angle inclination of blade is manual and individual for each blade. STS-S/G is equipped with a damper (standard - cantilevered damper).

The effective area and recommended diameter

Grille has Hygienic Certificate

Material and workmanship

Material:

- galvanized steel powder coated in RAL 9006 - standard
- aluminum powder coated
- stainless steel (type 1.4301 or 1.4404)

On request, it is possible to powder coated in any color RAL color.

The manufacturer reserves the right to make technological changes.

Size

Grilles are manufactured to order. Grilles dimension by the customer request - adapted to the existing spiro duct.

The minimum duct diameter for spiro grilles STS-S is 200mm.

L	H	A _{ef} (m ²)	minimum diameter of the duct f d
225	75	0,012	200
325	75	0,017	200
425	75	0,022	200
525	75	0,025	200
625	75	0,030	200
825	75	0,039	200
1025	75	0,048	200
1225	75	0,057	200
125	125	0,012	250
225	125	0,020	250
325	125	0,029	250
425	125	0,037	250
525	125	0,043	250
625	125	0,051	250
825	125	0,068	250
1025	125	0,085	250
1225	125	0,101	250
225	225	0,036	350
325	225	0,051	350
425	225	0,067	350
525	225	0,078	350
625	225	0,094	350
825	225	0,126	350
1025	225	0,158	350
1225	225	0,190	350
325	325	0,074	500
425	325	0,098	500
525	325	0,114	500
625	325	0,137	500
825	325	0,184	500
1025	325	0,231	500
1225	325	0,282	500
425	425	0,132	630
525	425	0,150	630
625	425	0,181	630
825	425	0,242	630
1025	425	0,304	630
1225	425	0,366	630
525	525	0,185	800
625	525	0,224	800
825	525	0,230	800
1025	525	0,377	800
1225	525	0,454	800
625	625	0,267	1000
825	625	0,359	1000
1025	625	0,450	1000
1225	625	0,542	1000



L,H - dimensions of the grille mounting hole

Holes in the frame to screw grille to the channel

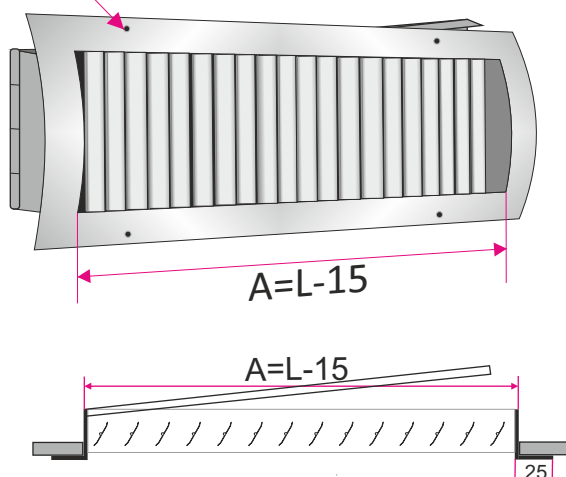

cantilevered damper GU

f d

B=H-15

A=L-15

A=L-15

25

25

30

TECHNICAL DATA

The dependence of pressure drop ($\Delta p_{..}$), maximum speed of air stream (V_{ef}), acoustic power level (L_{WA}) and the range air stream of speed $V=0,25$ m/s ($L_{0,25}$) of air volume flow (Q) with grilles at open dampers. Velocity V_{ef} means maximum speed of air outflow measured at the outlet the grille. Range $L_{0,25}$ refers to the distance at which the air speed does not exceed 0,25 m/s.

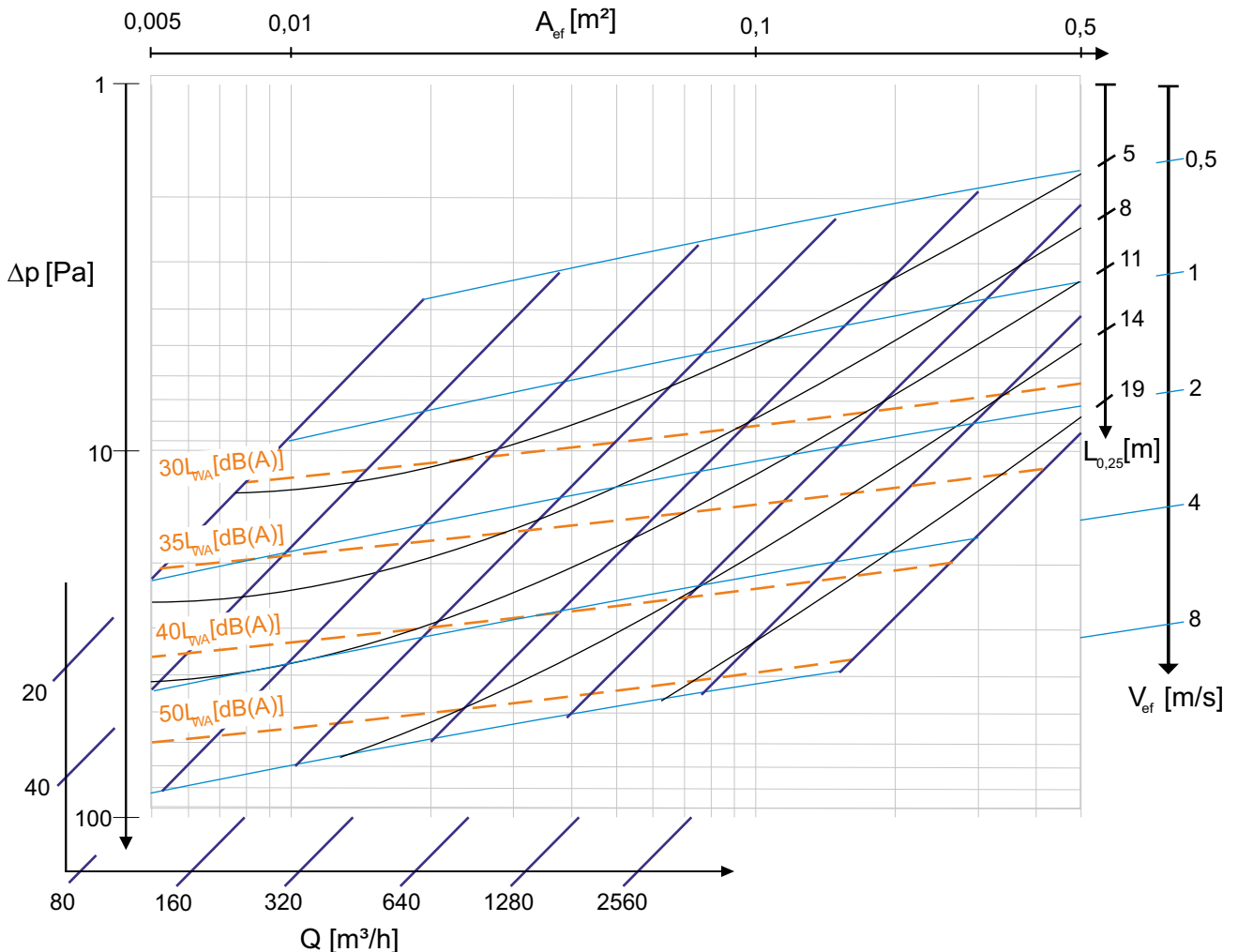
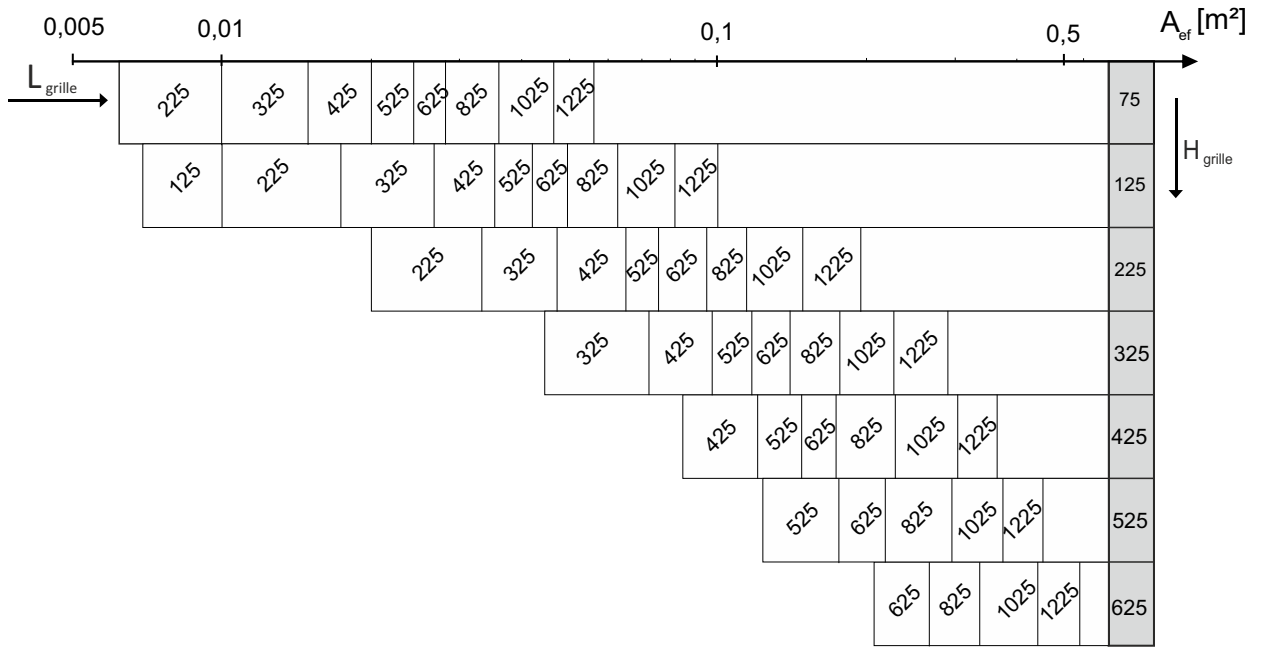

EXAMPLE

- specified air volume flow $Q=400 \text{ m}^3/\text{h}$
- range $L_{0,25}=8 \text{ m}$

Reading from the graph:

- suitable grille: 1025x225, 625x325, 425x425
- $A_{\text{ef}}=0,13 \text{ m}^2$
- pressure drop: 7 Pa
- effective speed at the outlet: 1,6 m/s
- acoustic power <30 dB

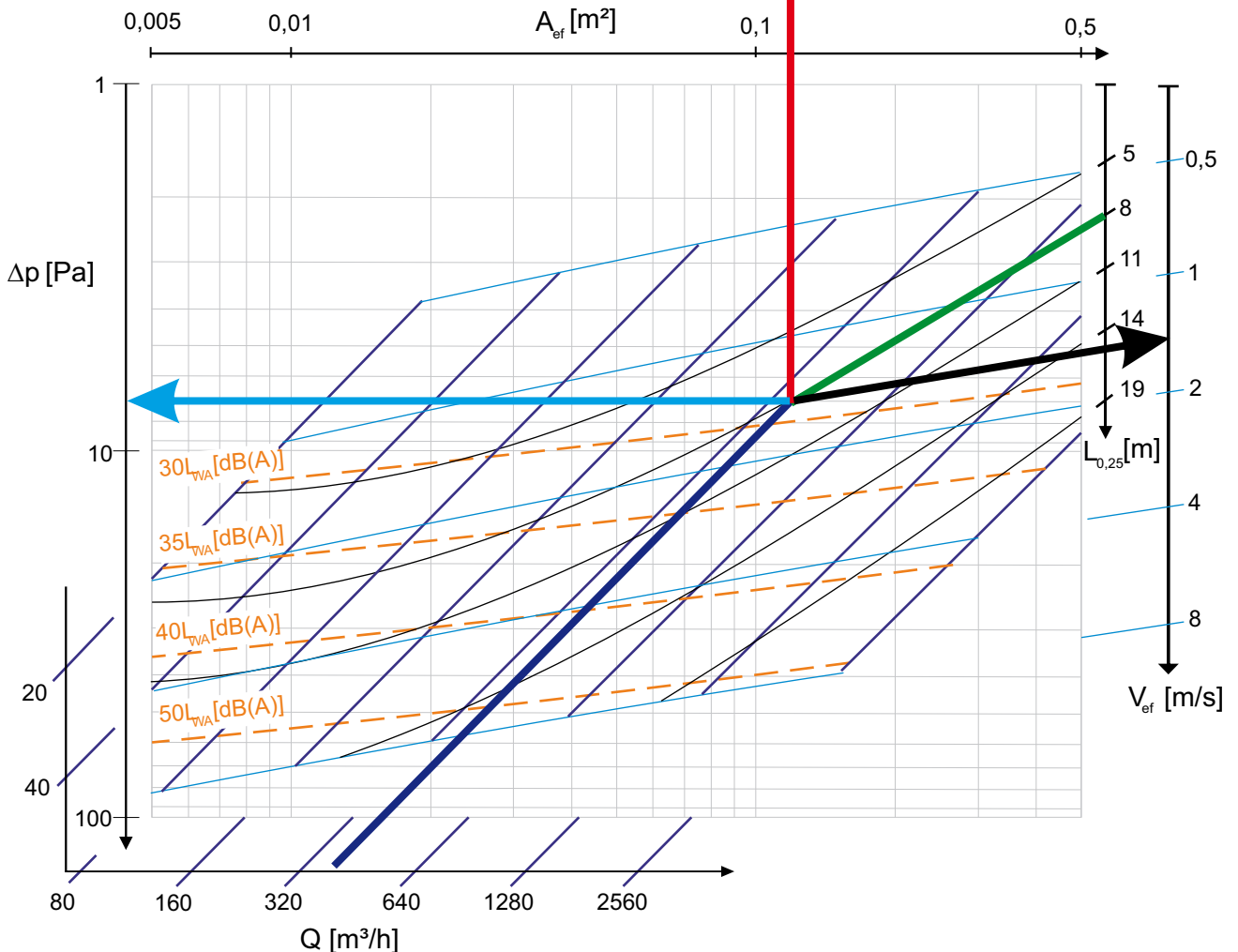
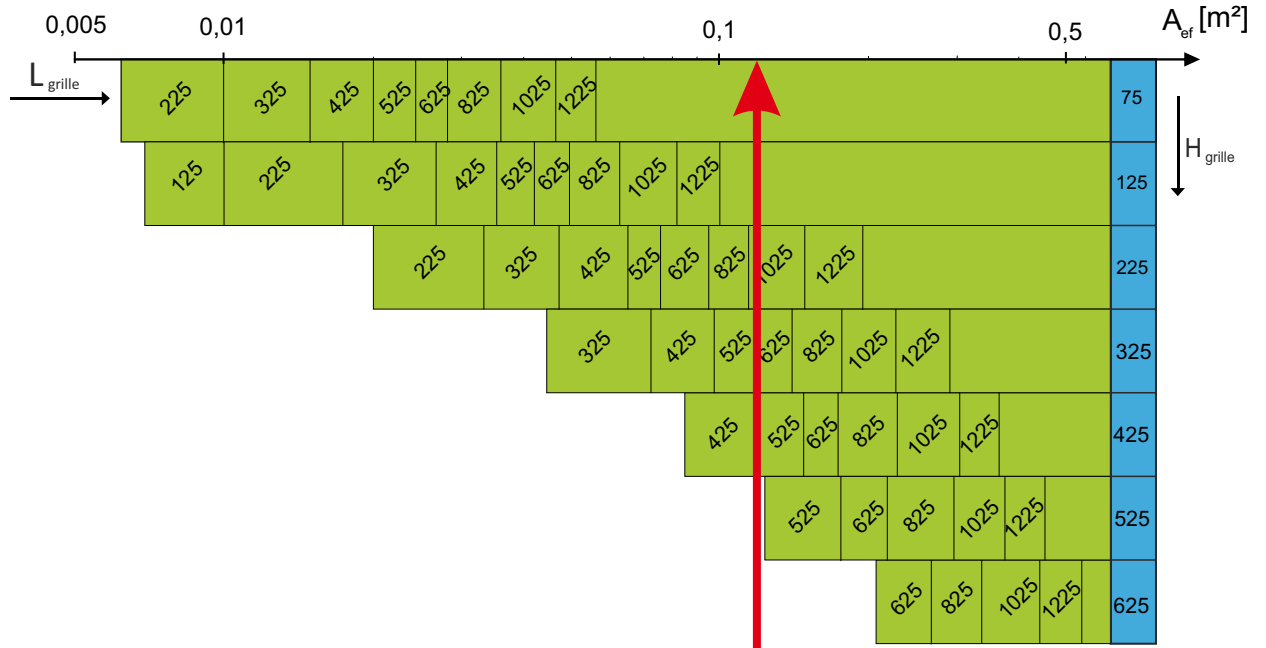

Accessories- dampers

Grille STS-S/G is equipped with a damper, positioned directly behind the grille blades. In this type of grille damper control is from the front side of grille without need to disassembly, by the deflection of grille blades. Below there are the types of dampers used for the ventilation grilles (standard - catilevered damper).

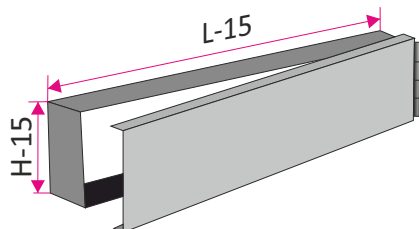

GU - cantilevered damper
(especially recommended for grills to spiro channel)

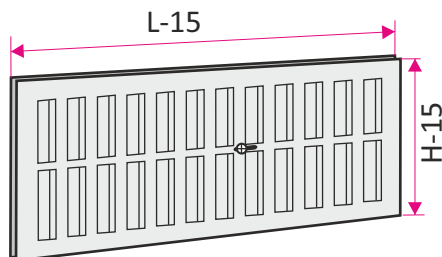

GS - slot damper
(above the size of 525x425 the damper must be divided)

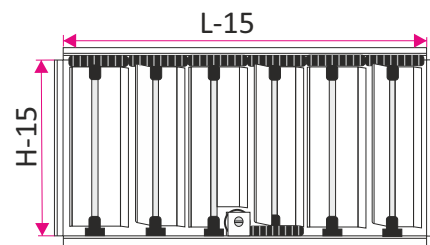

GP - damper with counter running blades
(above the size of 525x425 the damper must be divided)

The method of placing an order

Please make orders according to the following formula:

STS-S/'G' / 'LxH' / 'Dn' / 'W' / 'RAL'

'G'	- damper type: GP - damper with counter running blades GS - slot damper GU - cantilevered damper*
'LxH'	- mounting hole size (width x height) in mm
'Dn'	- the spiro channel diameter (160, 200, 250, 315...)
'W'	- made of: OC - powder coated steel (standard in RAL 9006) AL - aluminum powder coated KO - stainless steel / acid proof steel (type 1.4301 or 1.4404)
'RAL'	- grille color according to RAL palette

* - If you don't give the information will be used standard parameters.